

Knock out system

Knock out system

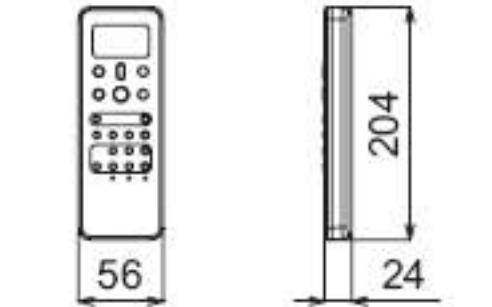

Wireless remote controller

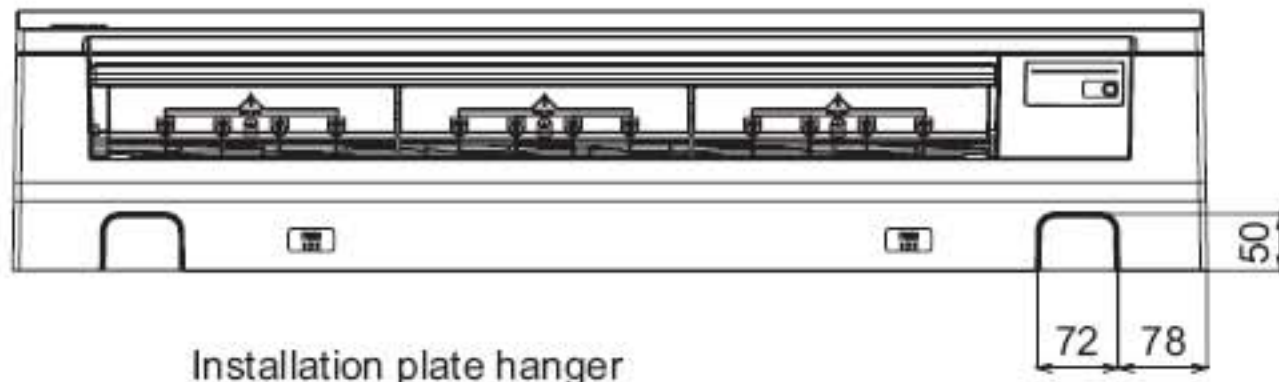
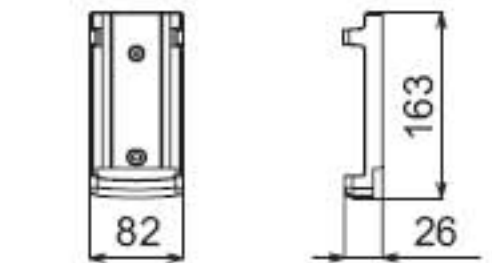
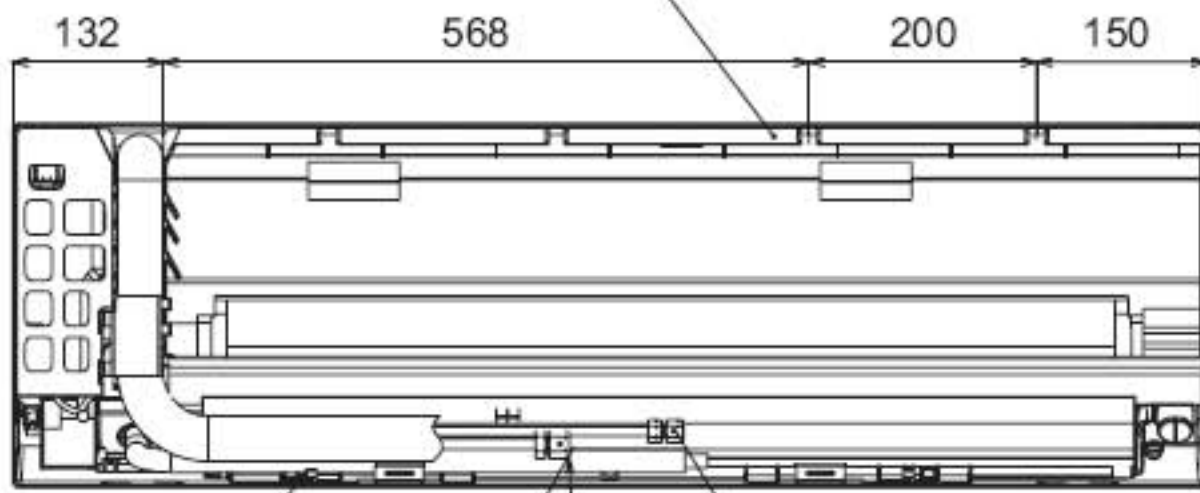

Remote controller holder

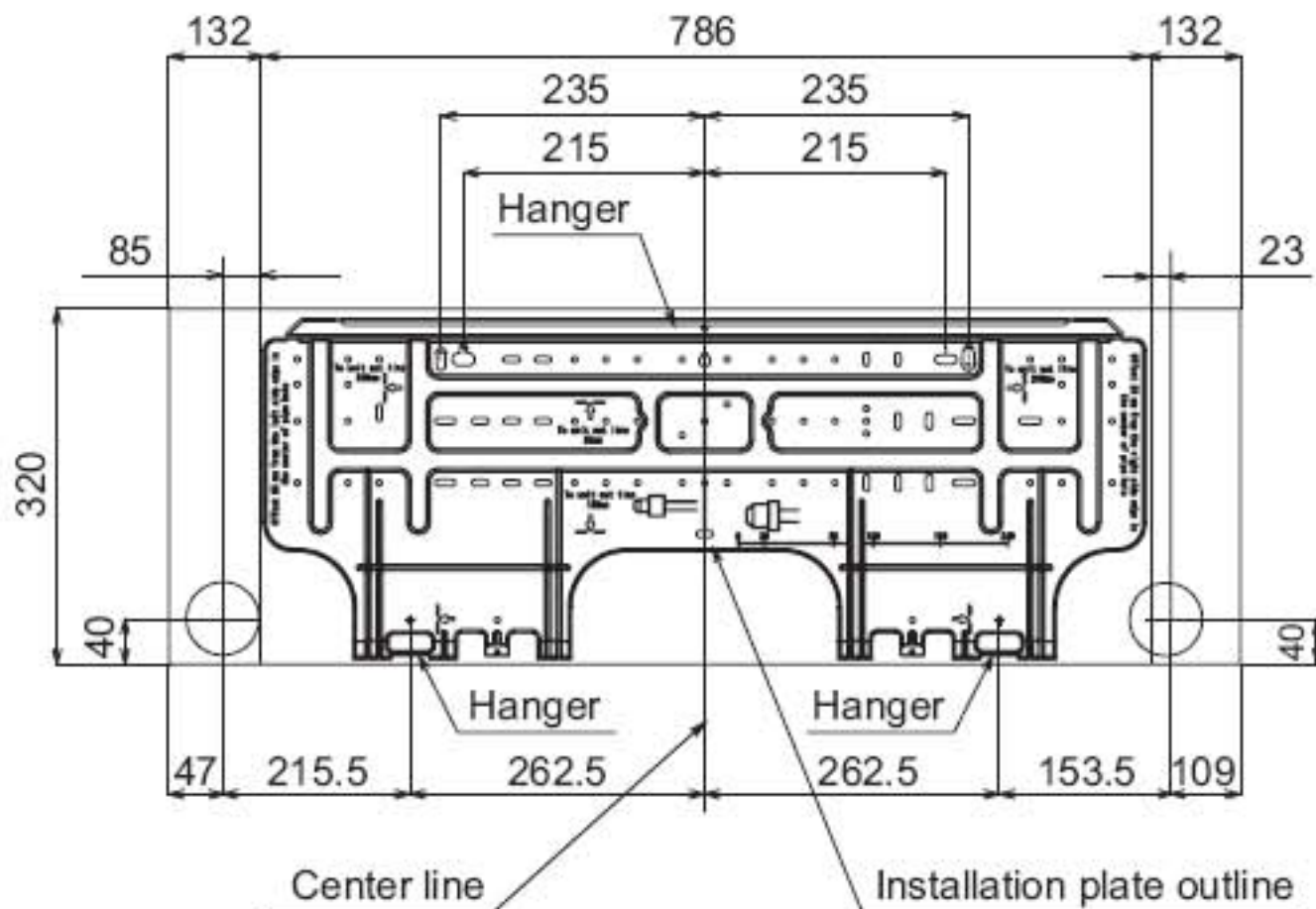
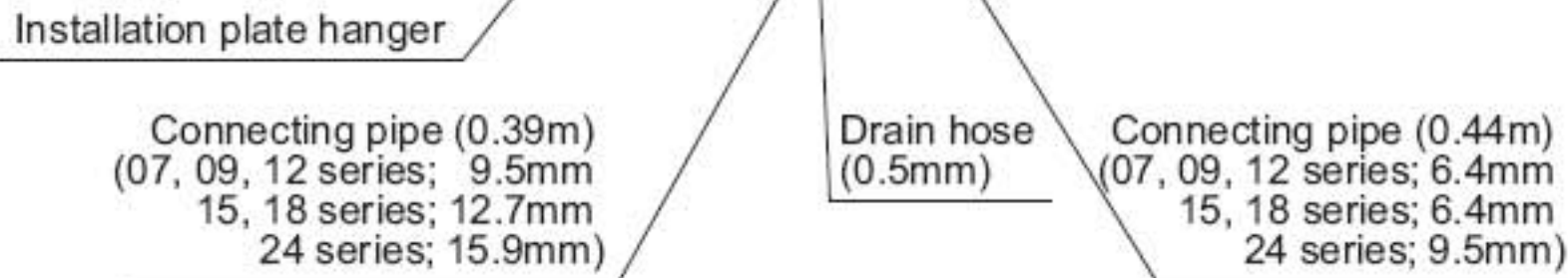

Installation plate

Space required for installation and servicing

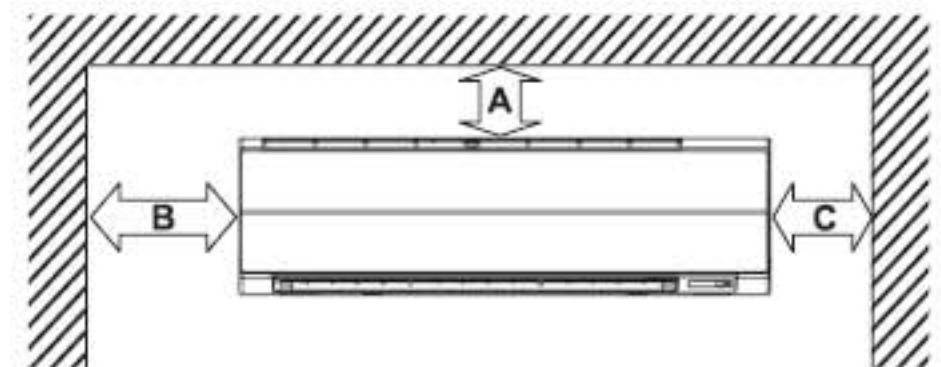

	Distance	Comments
A	110 or more	
B	850 or more	For exchange of cross flow fan
C	170 or more	